



Univerzální montážní plán

Domek se sedlovou střechou

Zahradní domky
MICHAL ZELMAN

www.nejzahradnidomek.cz



NEJ
ZAHRADNI
DOMEK.CZ

Počet opěrných bodů podle velikosti půdorysu podlahy (šířka × délka)

Půdorys o šířce 375 cm

375 x 625 cm

32 opěrných bodů.

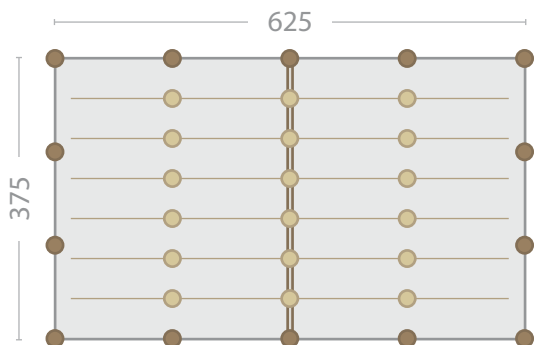

375 x 500 cm

32 opěrných bodů.

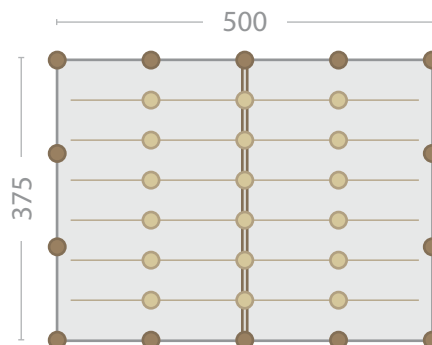

375 x 375 cm

24 opěrných bodů.

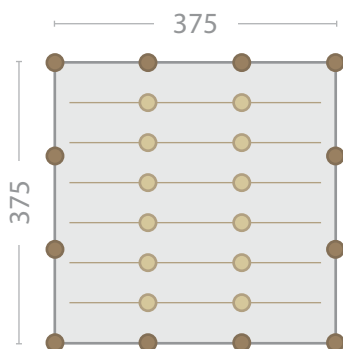

Půdorys o šířce 300 cm

300 x 500 cm

29 opěrných bodů.

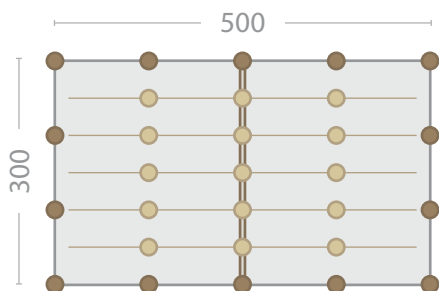

300 x 375 cm

22 opěrných bodů.

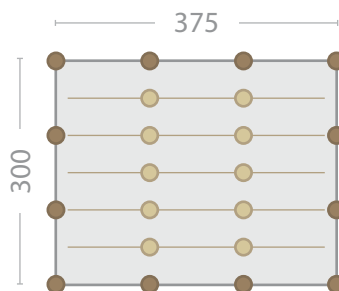

300 x 300 cm

17 opěrných bodů.

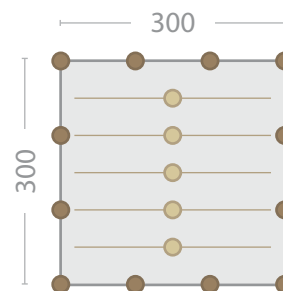

Půdorys o šířce 250 cm (resp. 240 cm)

250 x 626 cm

22 opěrných bodů.

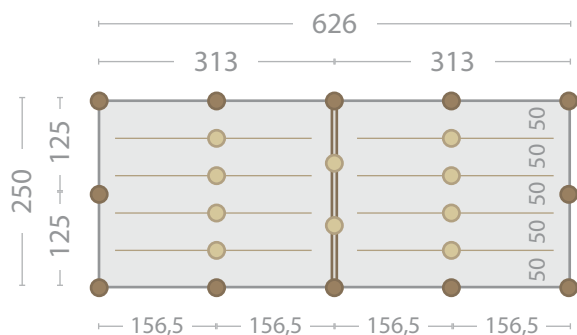
**250 x 500 cm**

23 opěrných bodů.

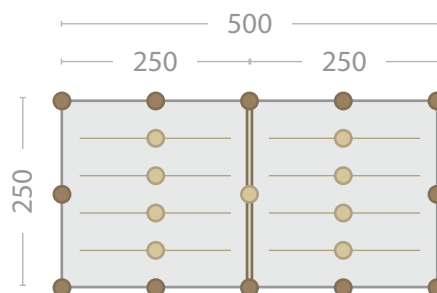
**250 x 375 cm**

18 opěrných bodů.

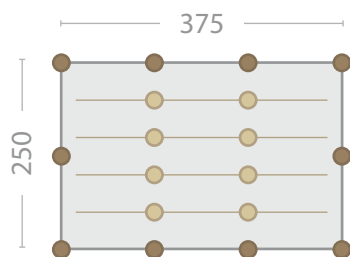
**250 x 250 cm**

12 opěrných bodů.

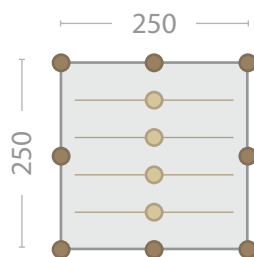

Půdorys o šířce 125 cm

125 x 375 cm

12 opěrných bodů.

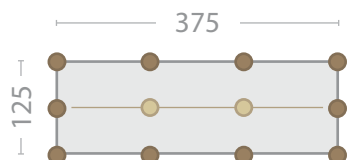
**125 x 250 cm**

9 opěrných bodů.

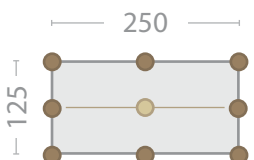
**125 x 150 cm**

9 opěrných bodů.

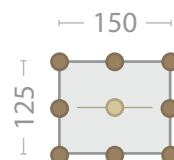

Základní rošt pro podlahu (vzorový – v závislosti na typu domku)

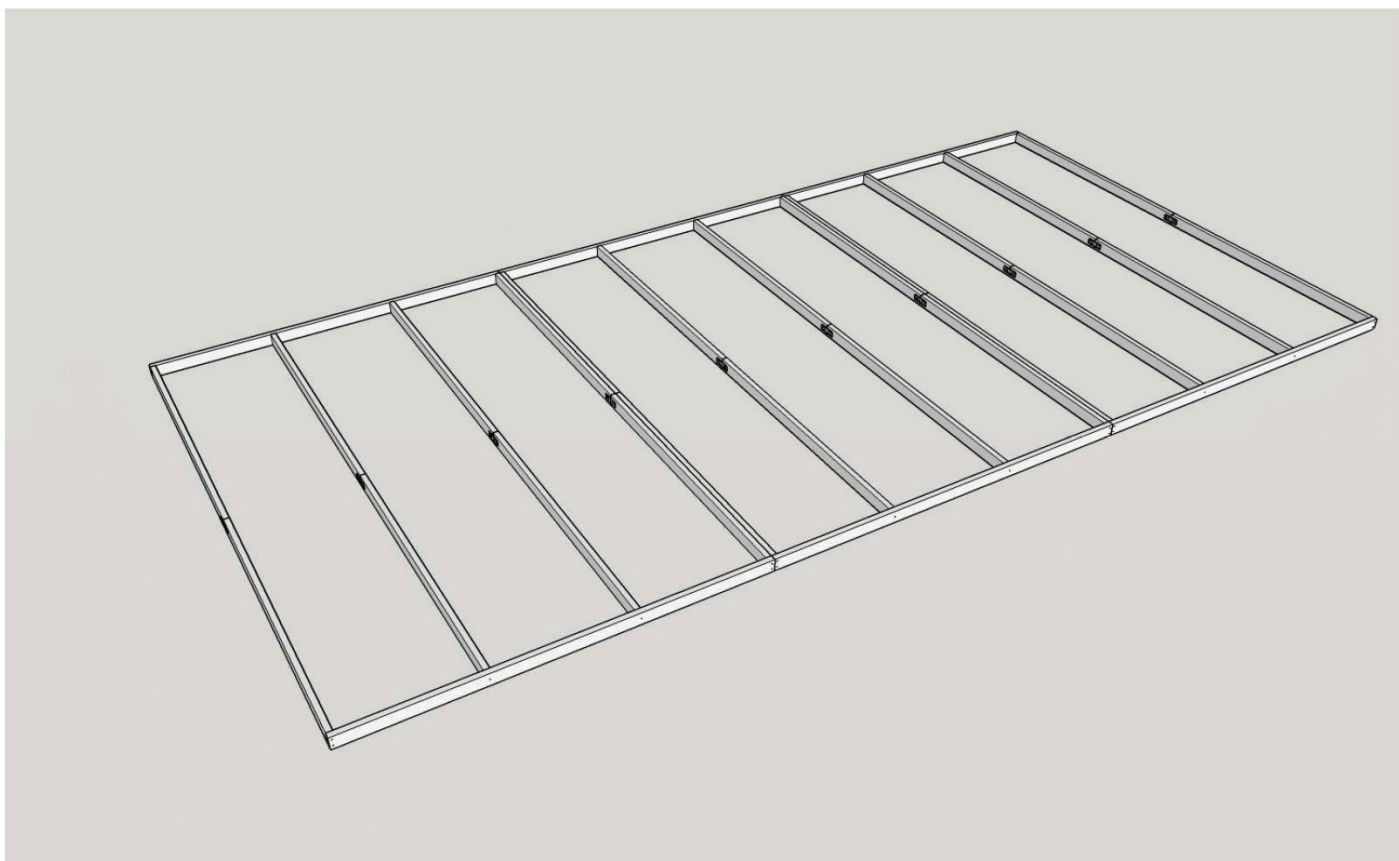
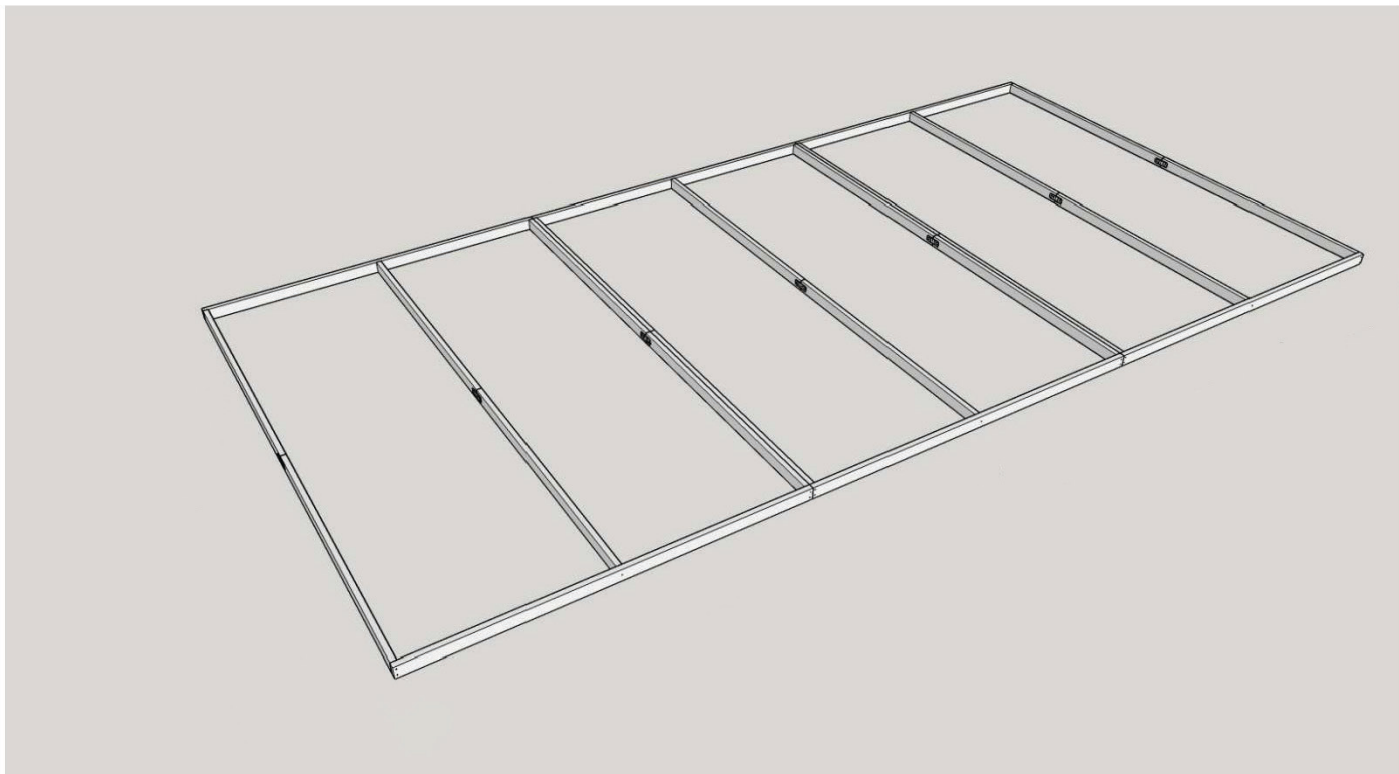

Kladení podlahy (vzorové – v závislosti na typu domku)

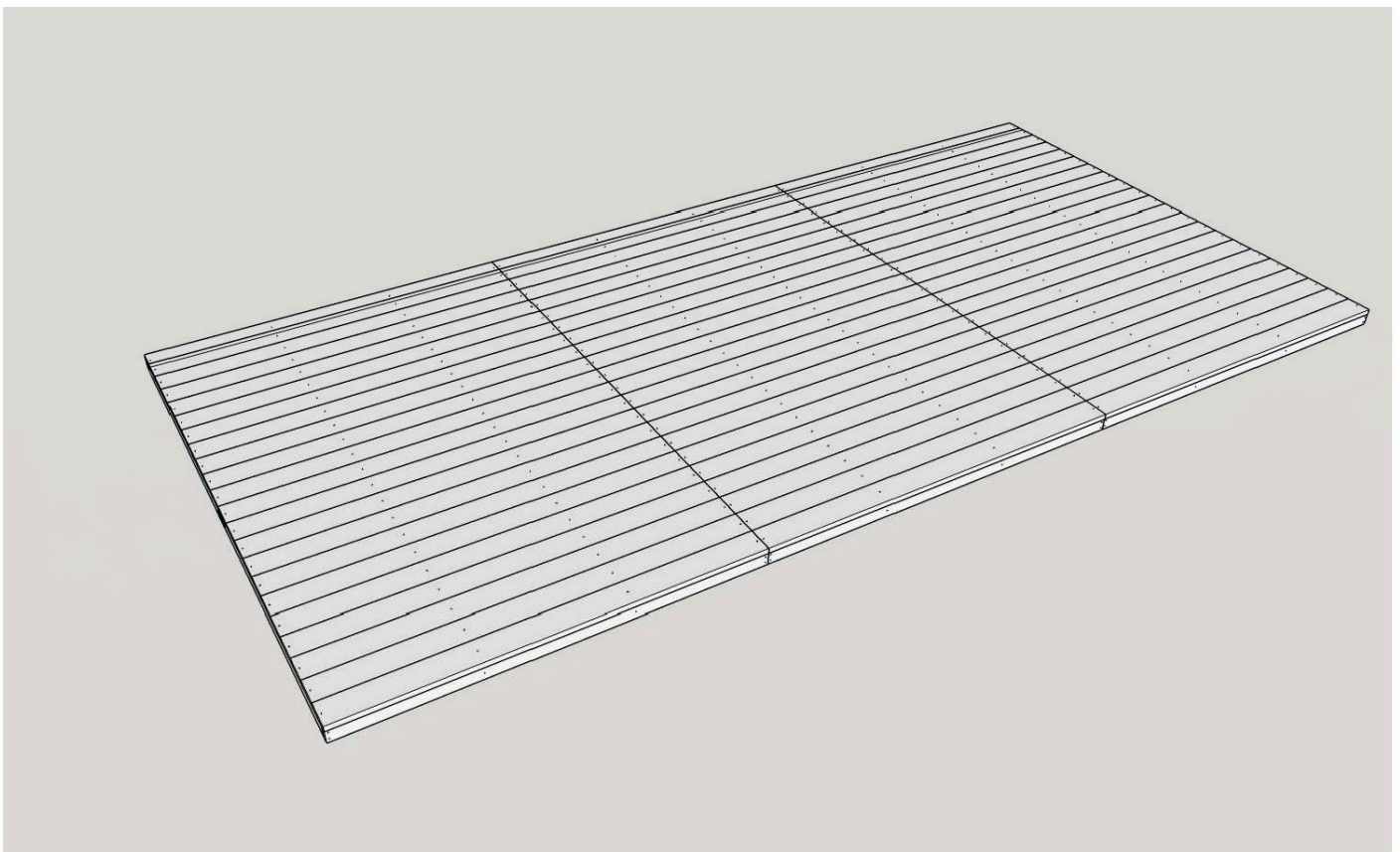
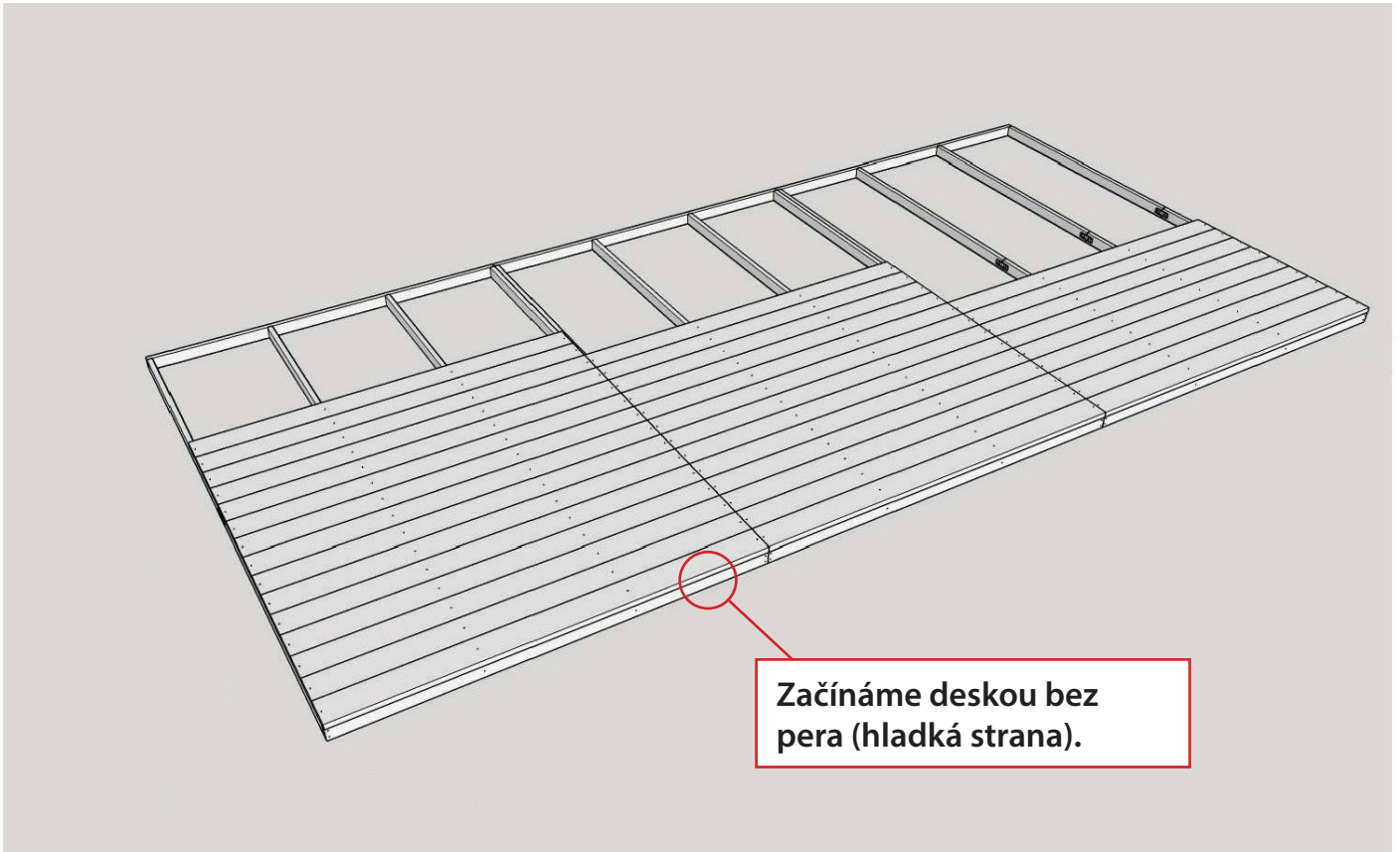

Uložení stěn domku

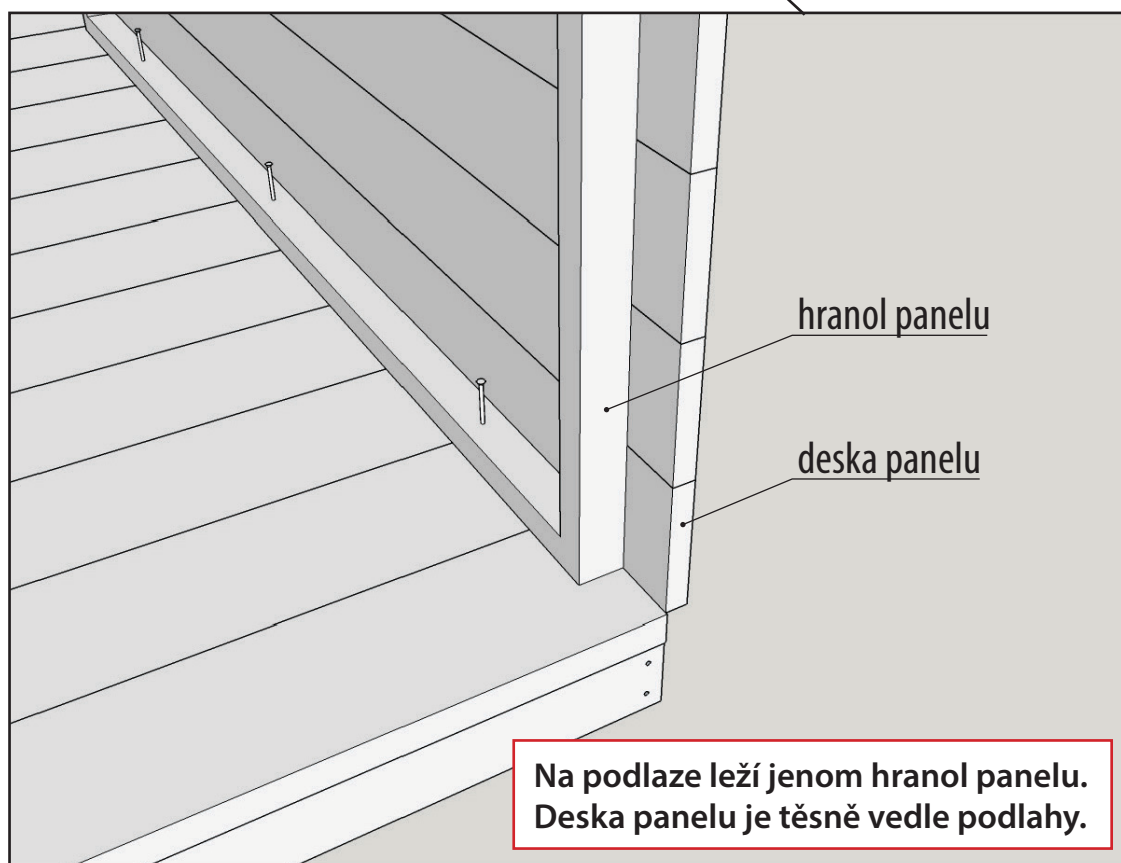
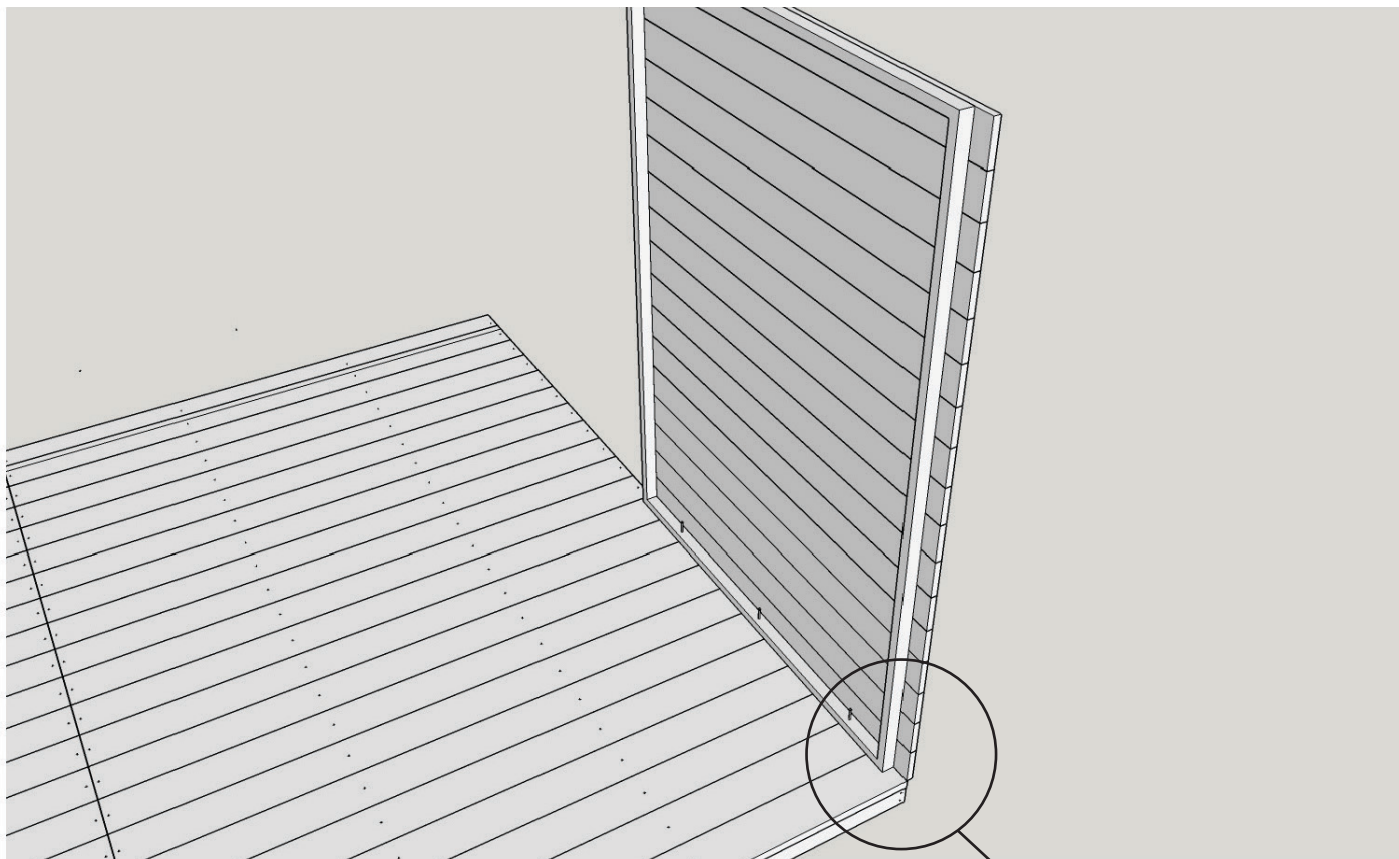

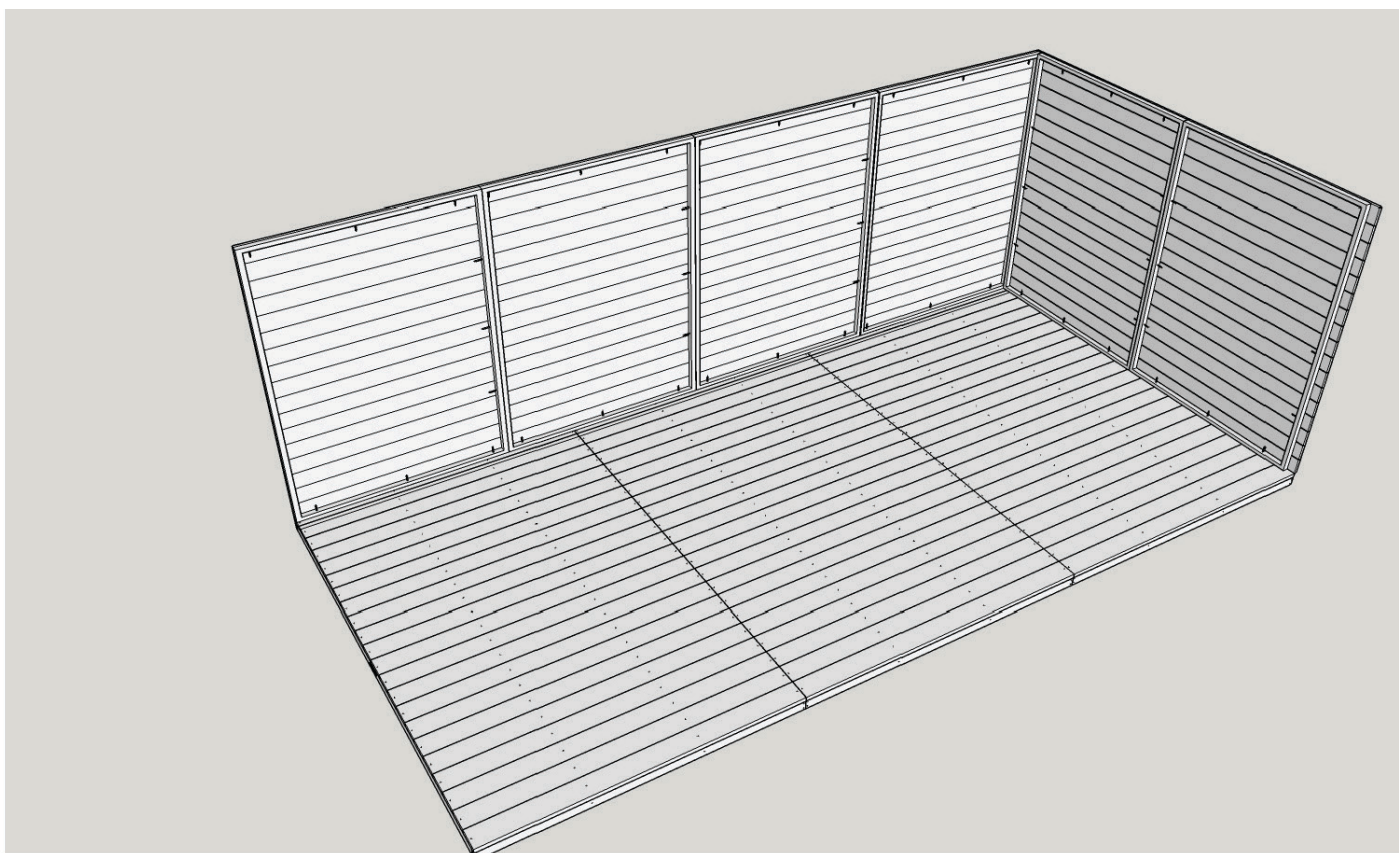
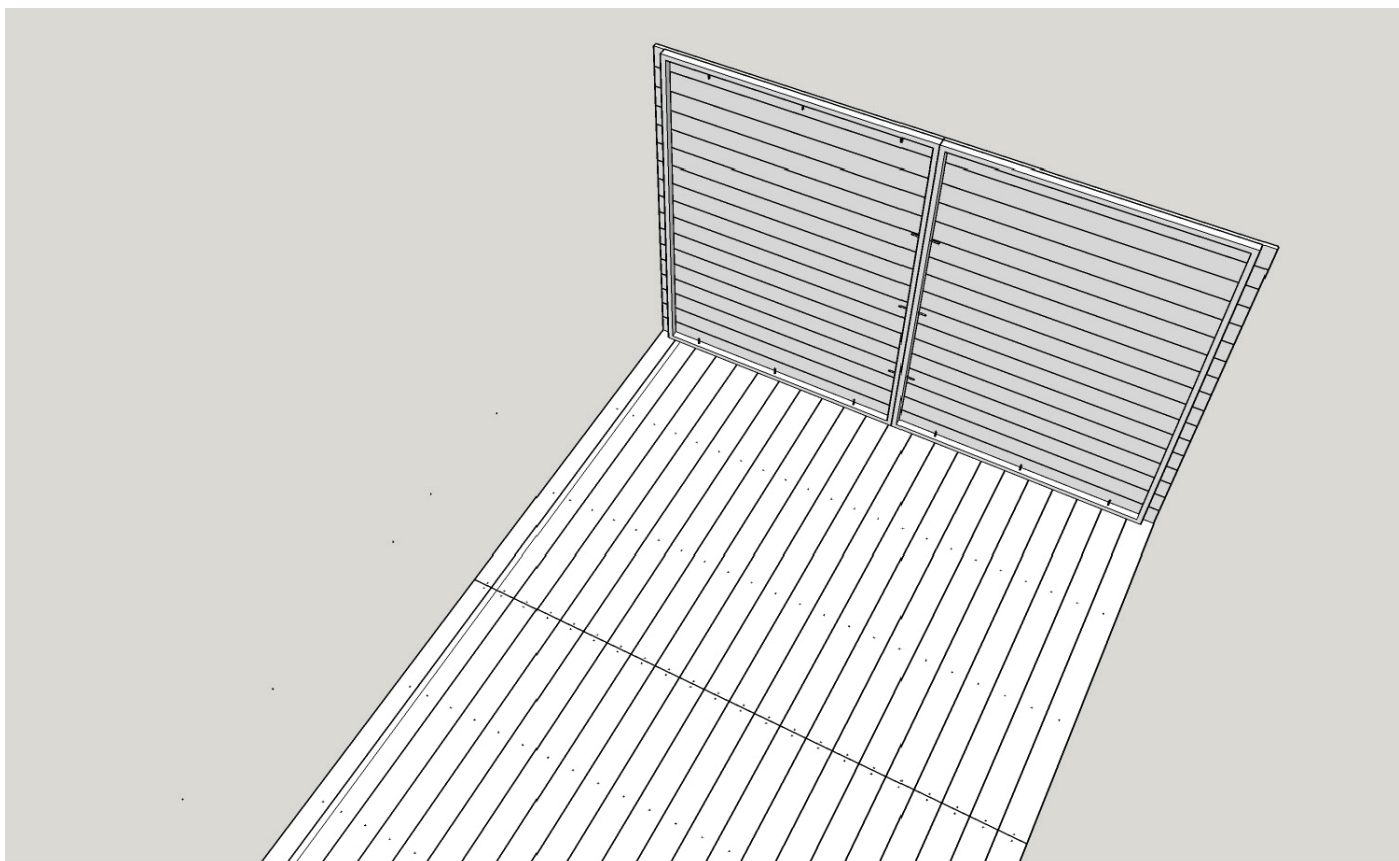

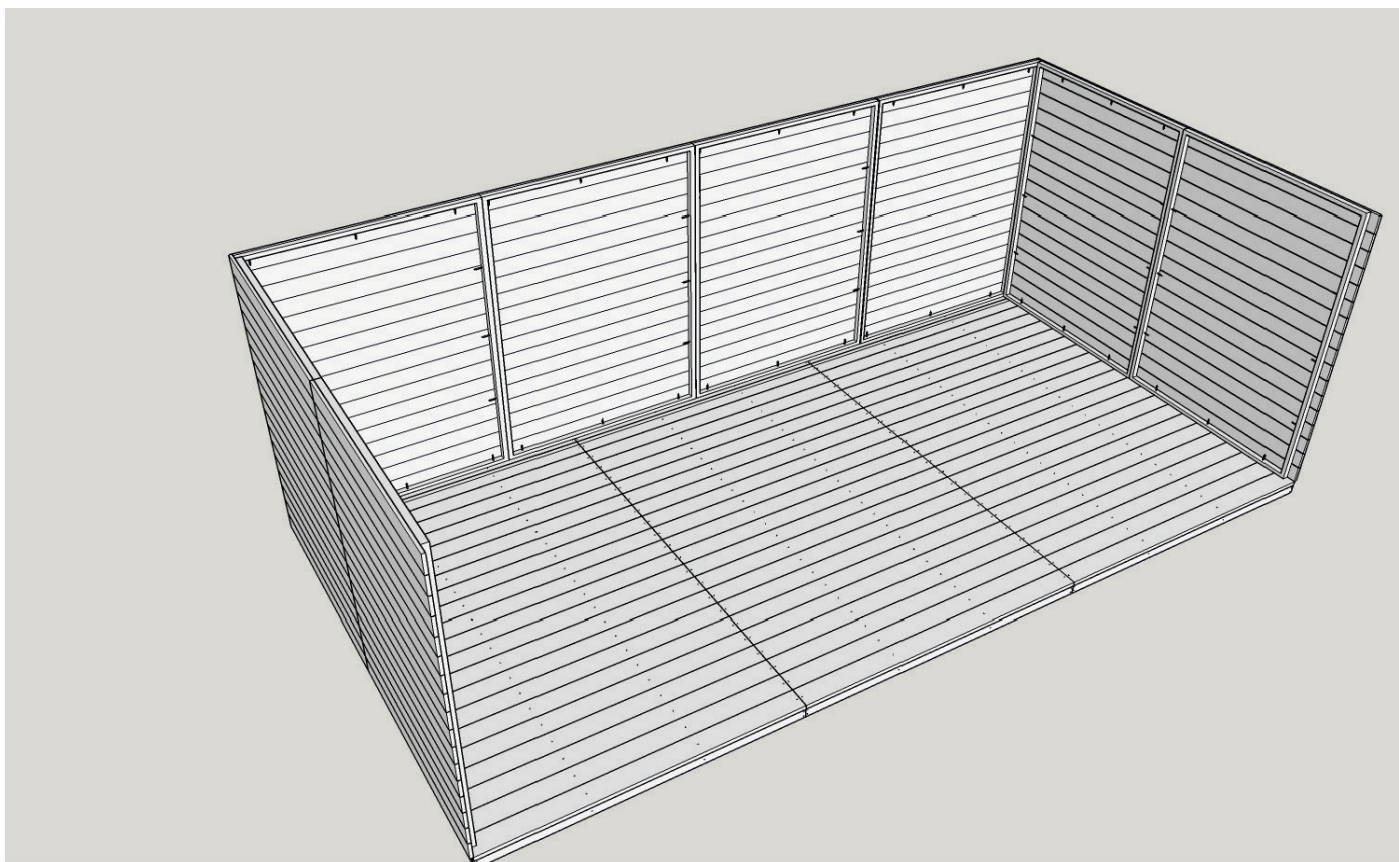
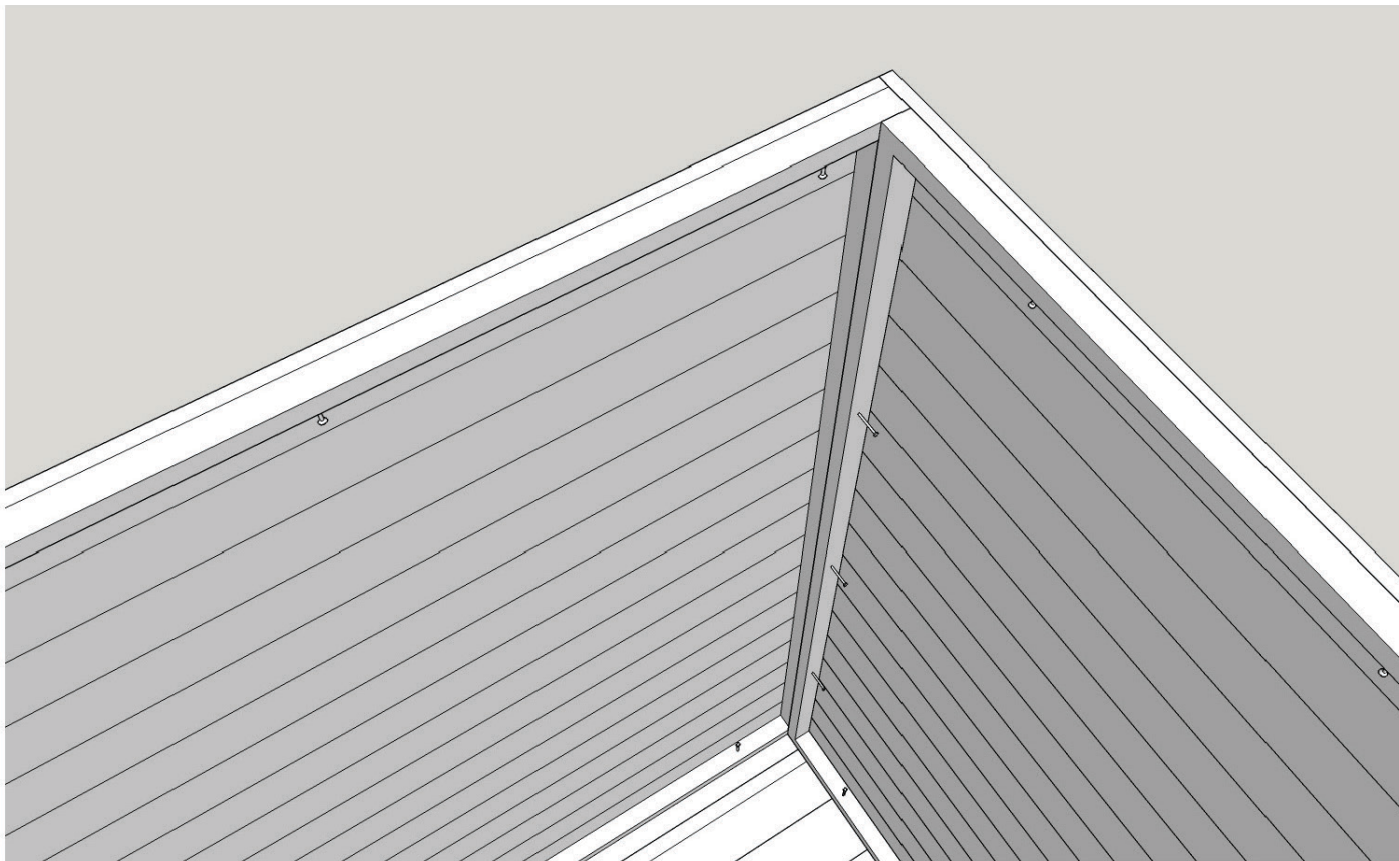

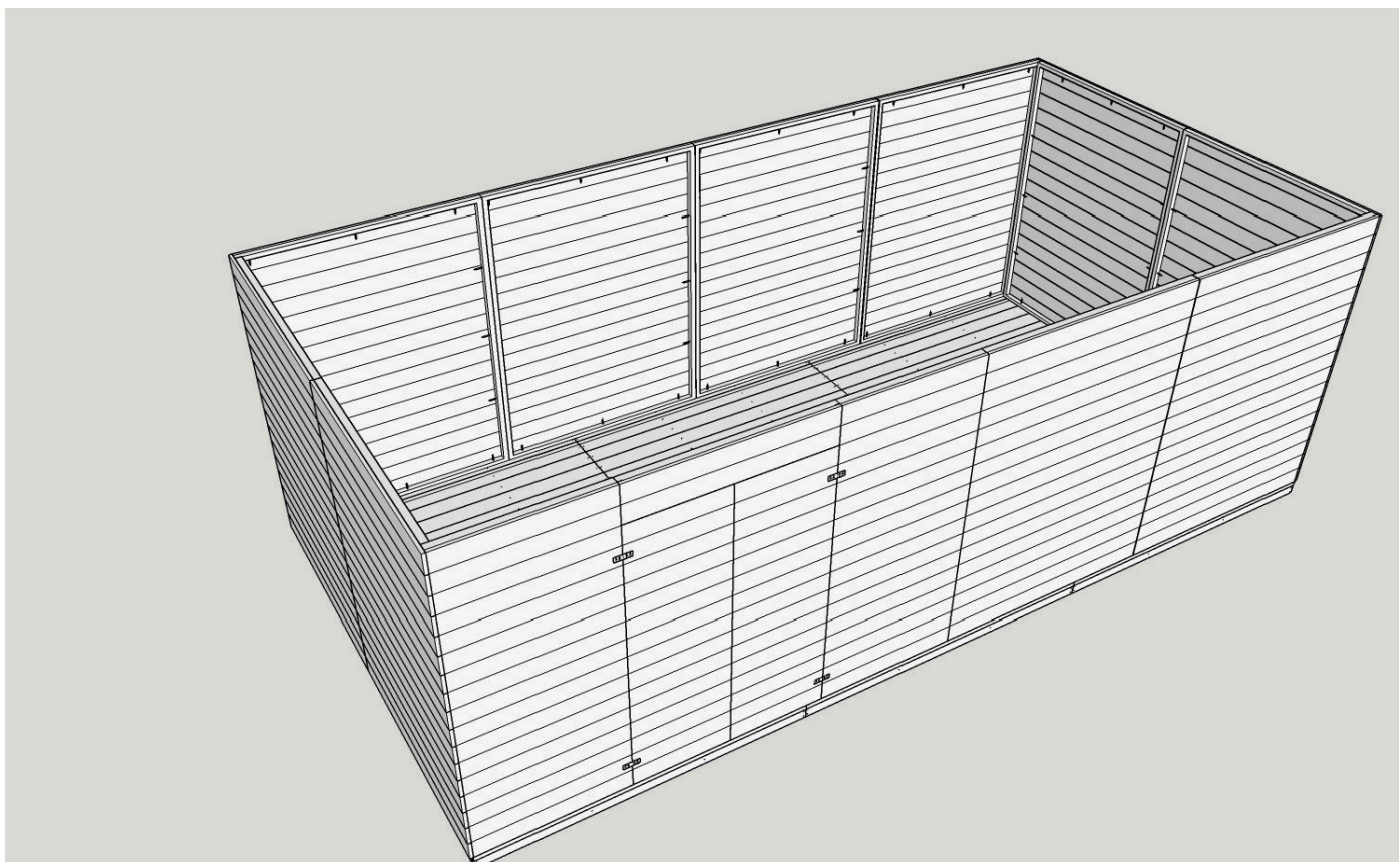
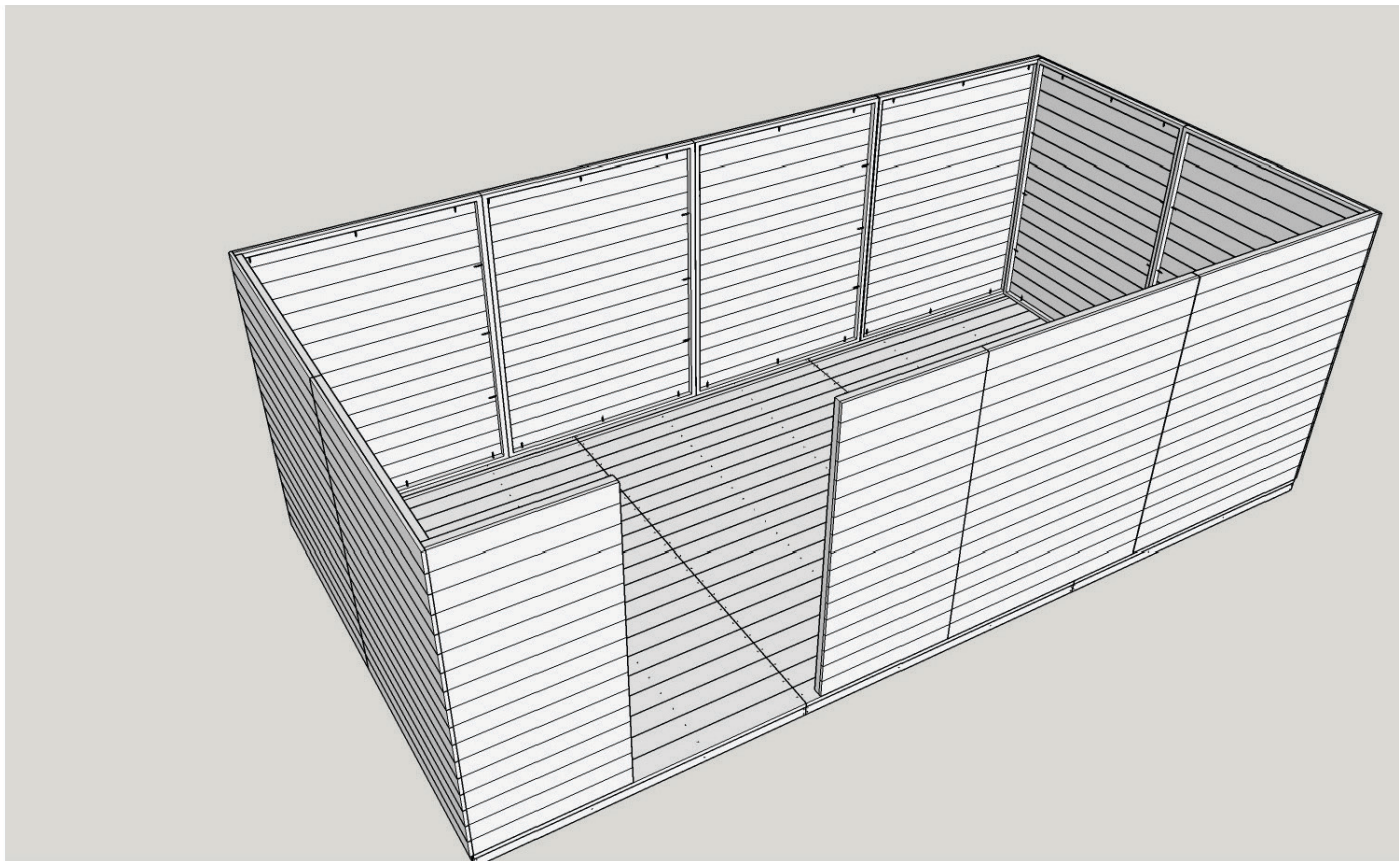

Uložení konstrukce střechy

Boční trojúhelník

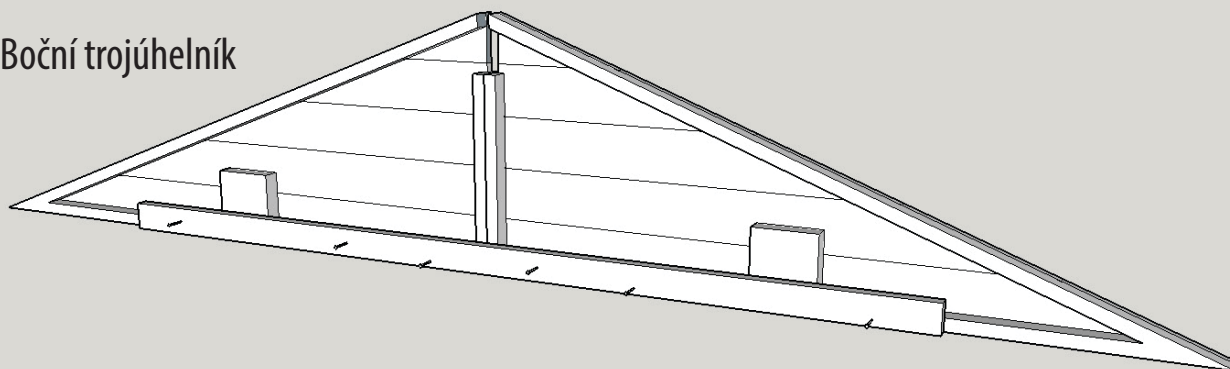

Vnitřní trojúhelník

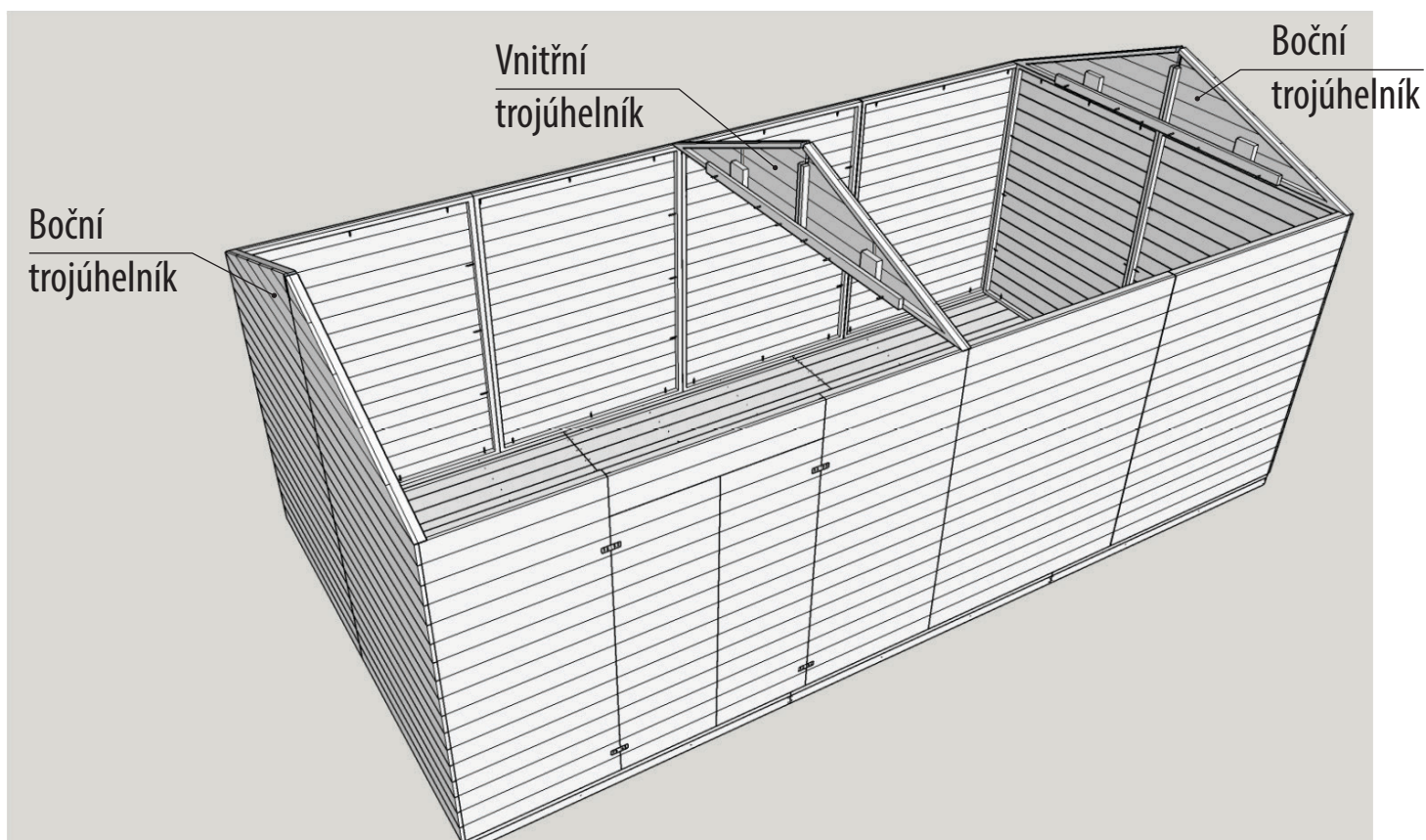
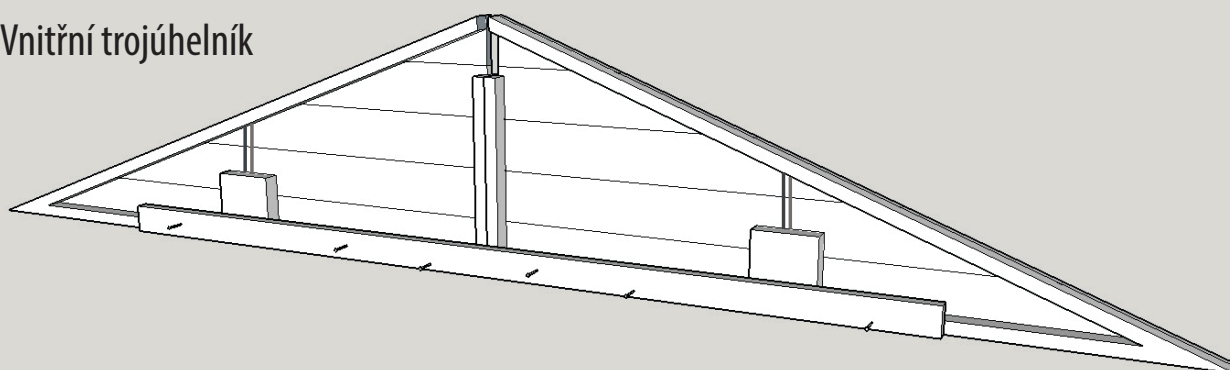

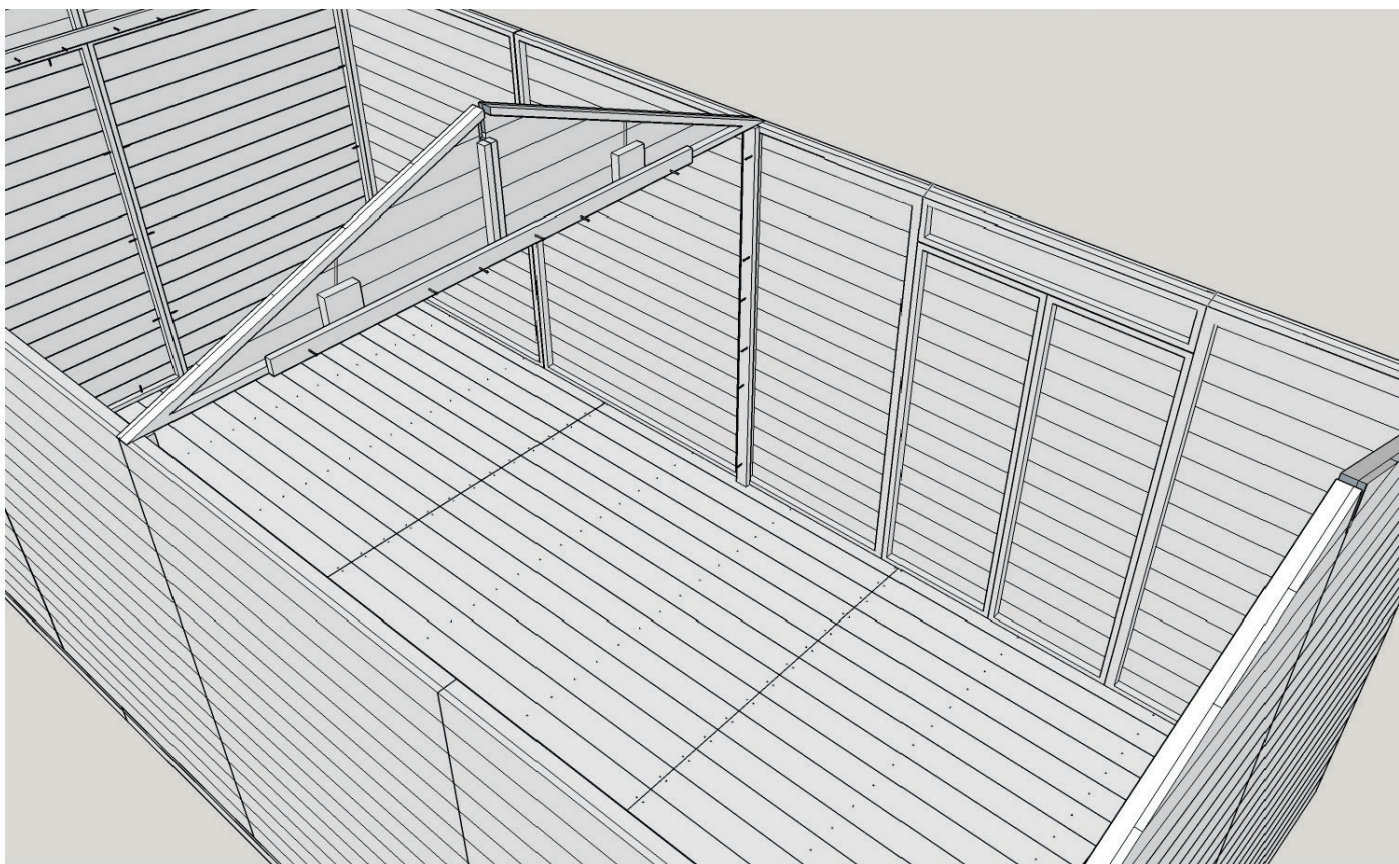
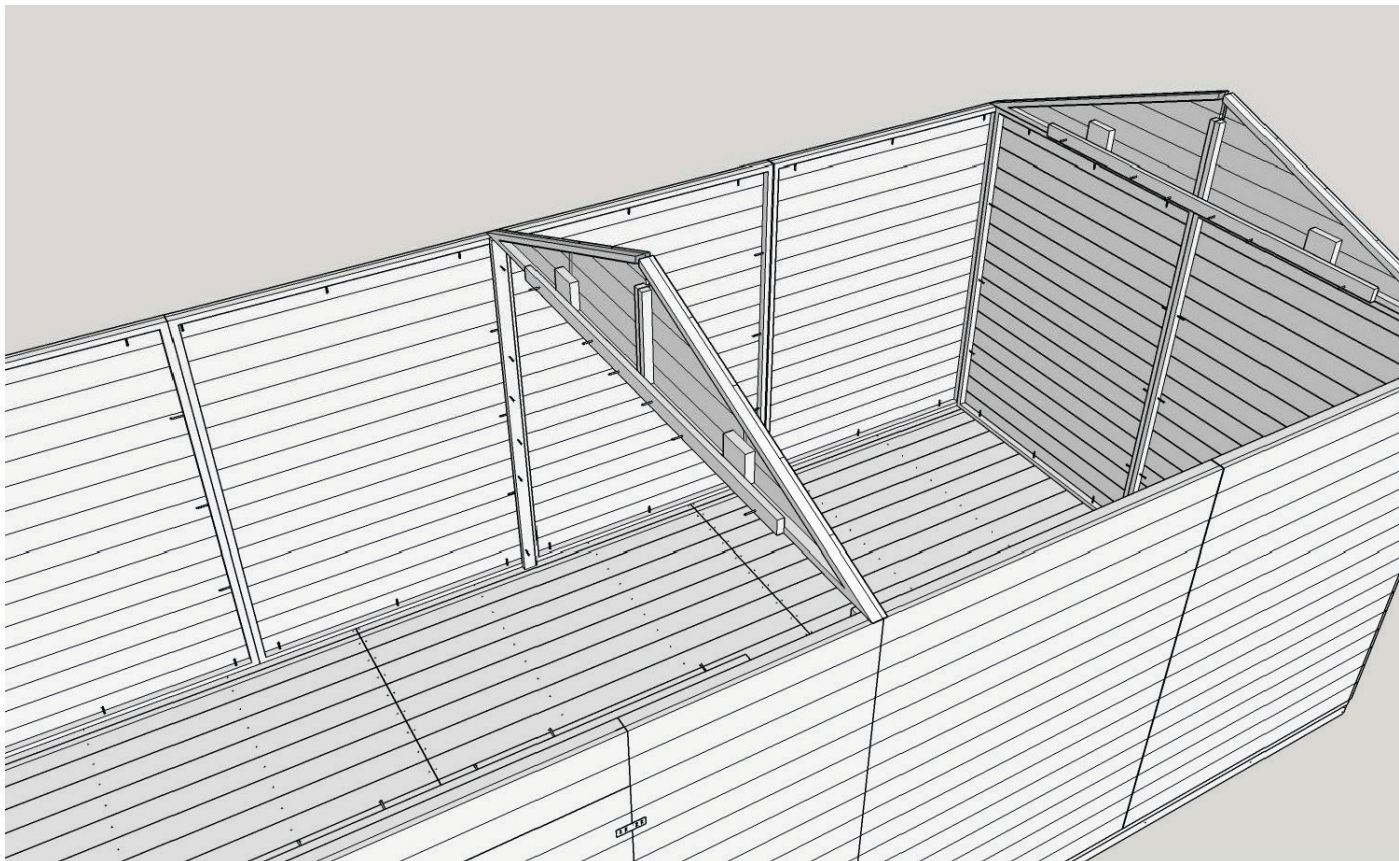

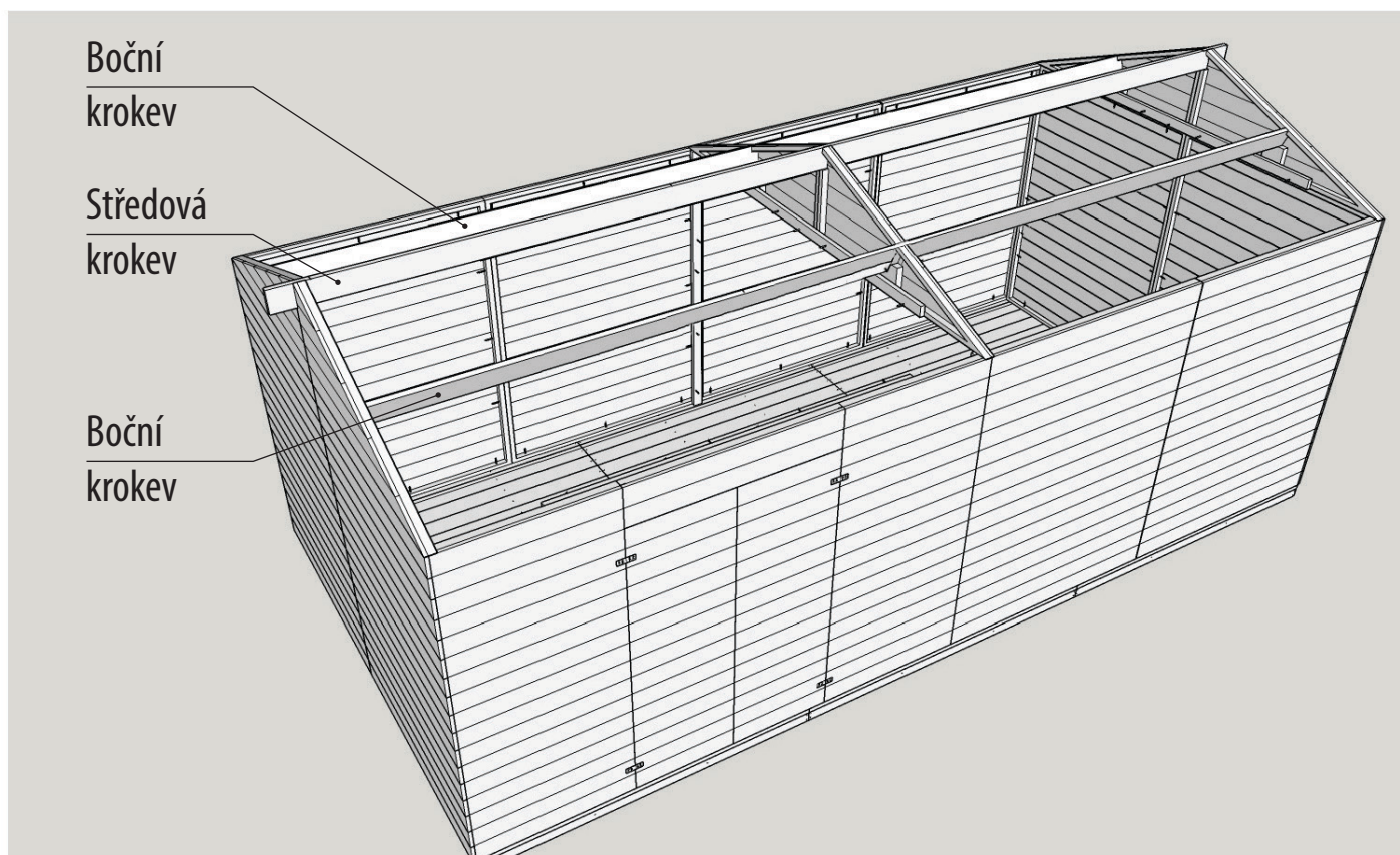
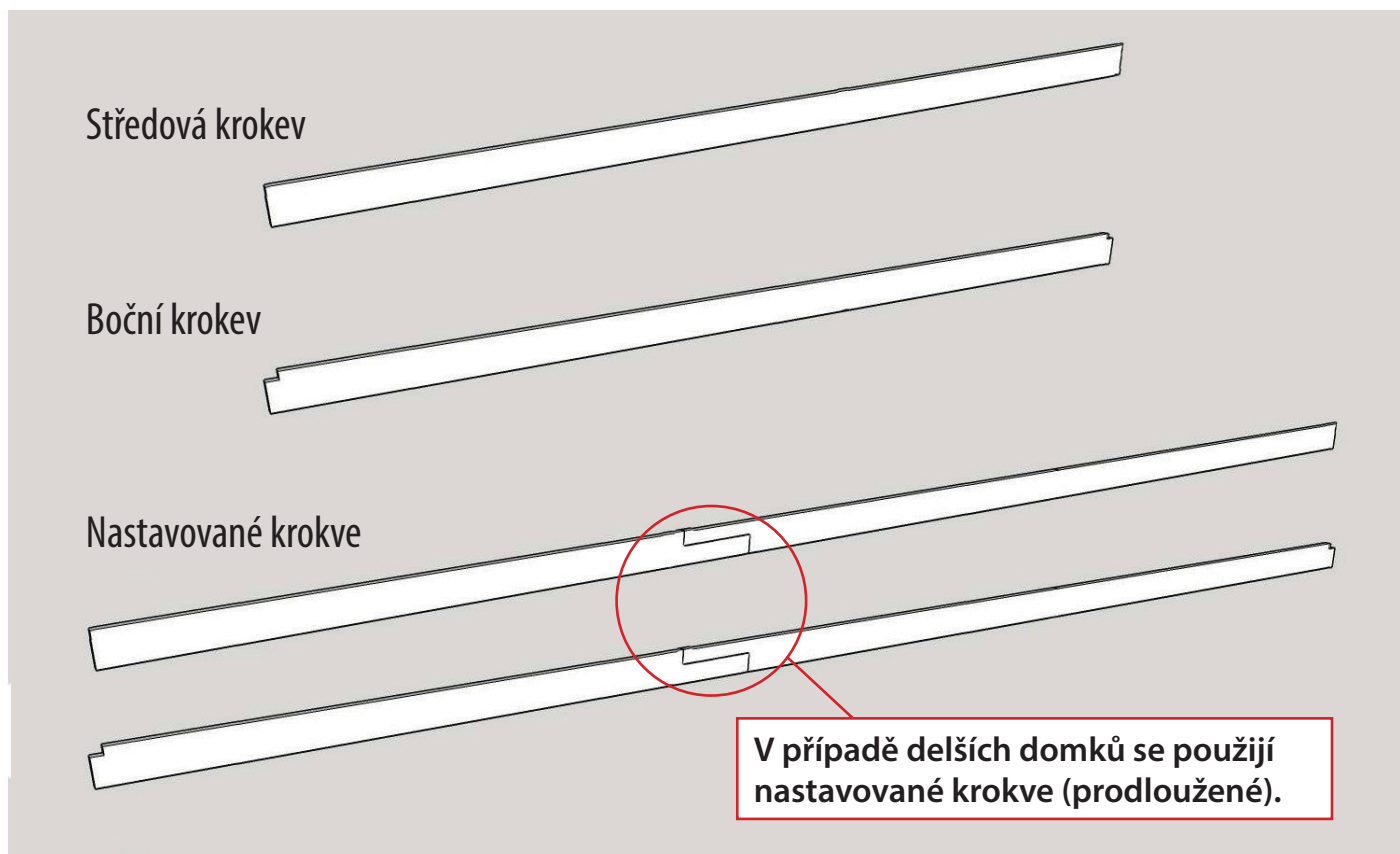

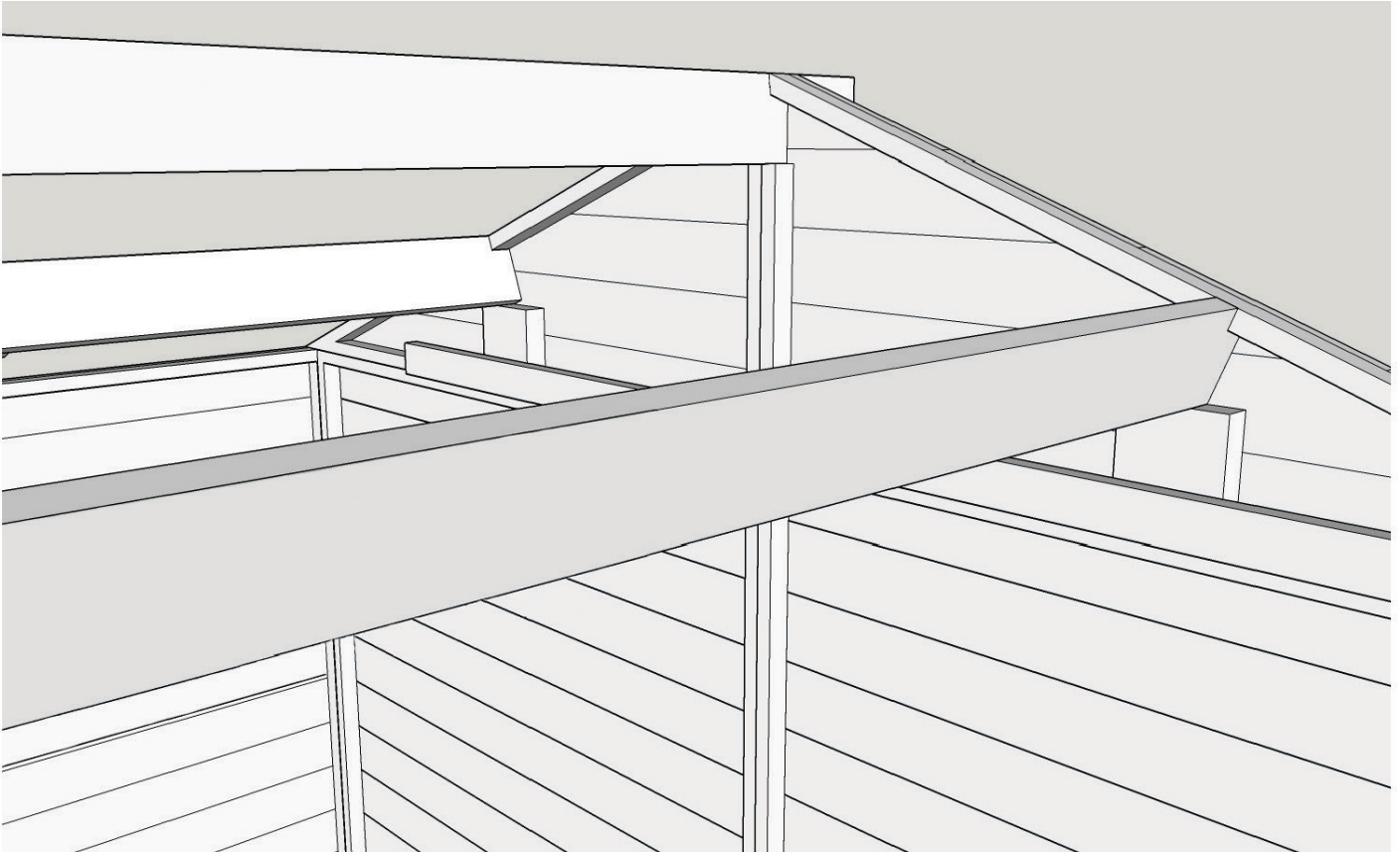

Uložení pokrytí střechy

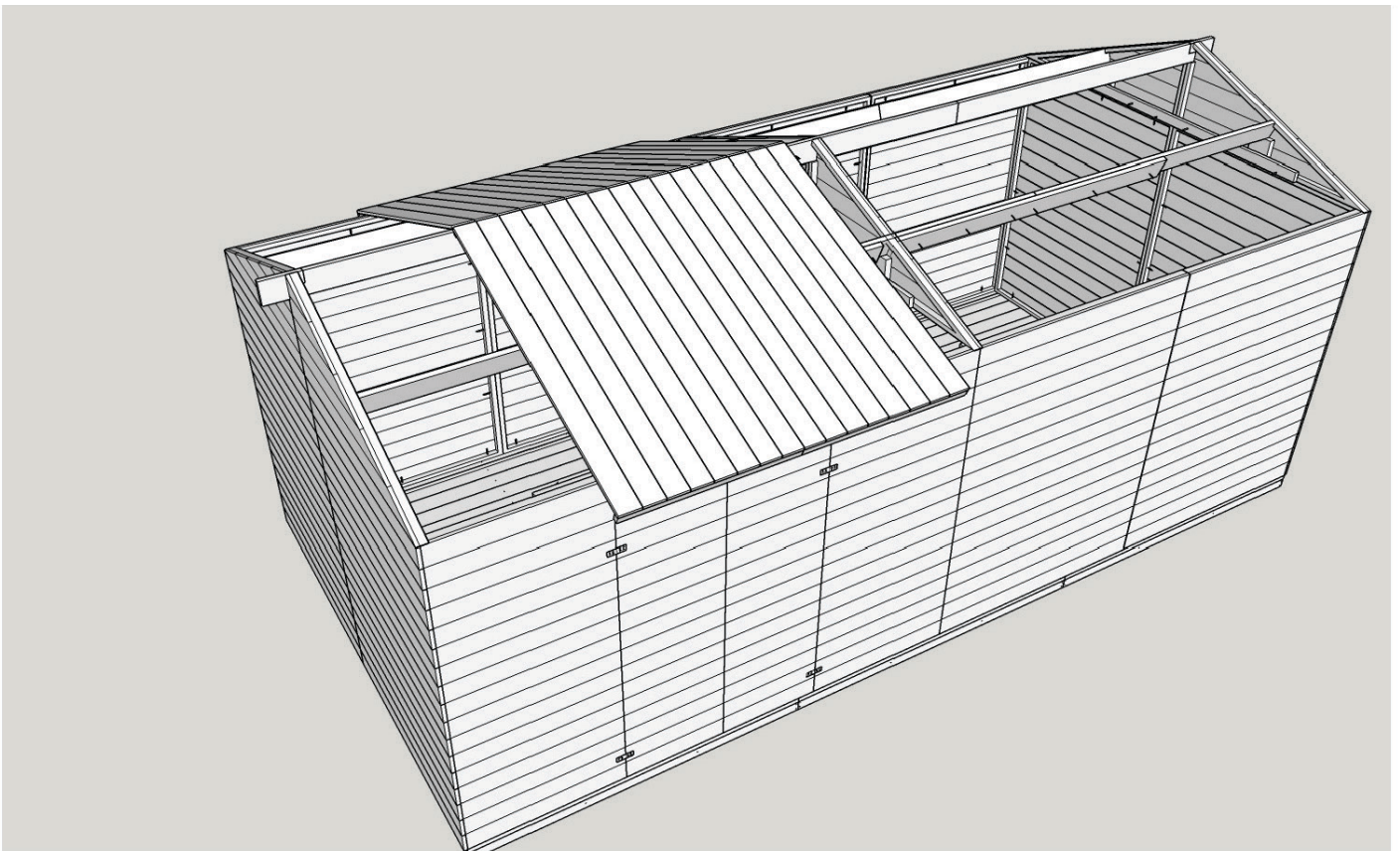

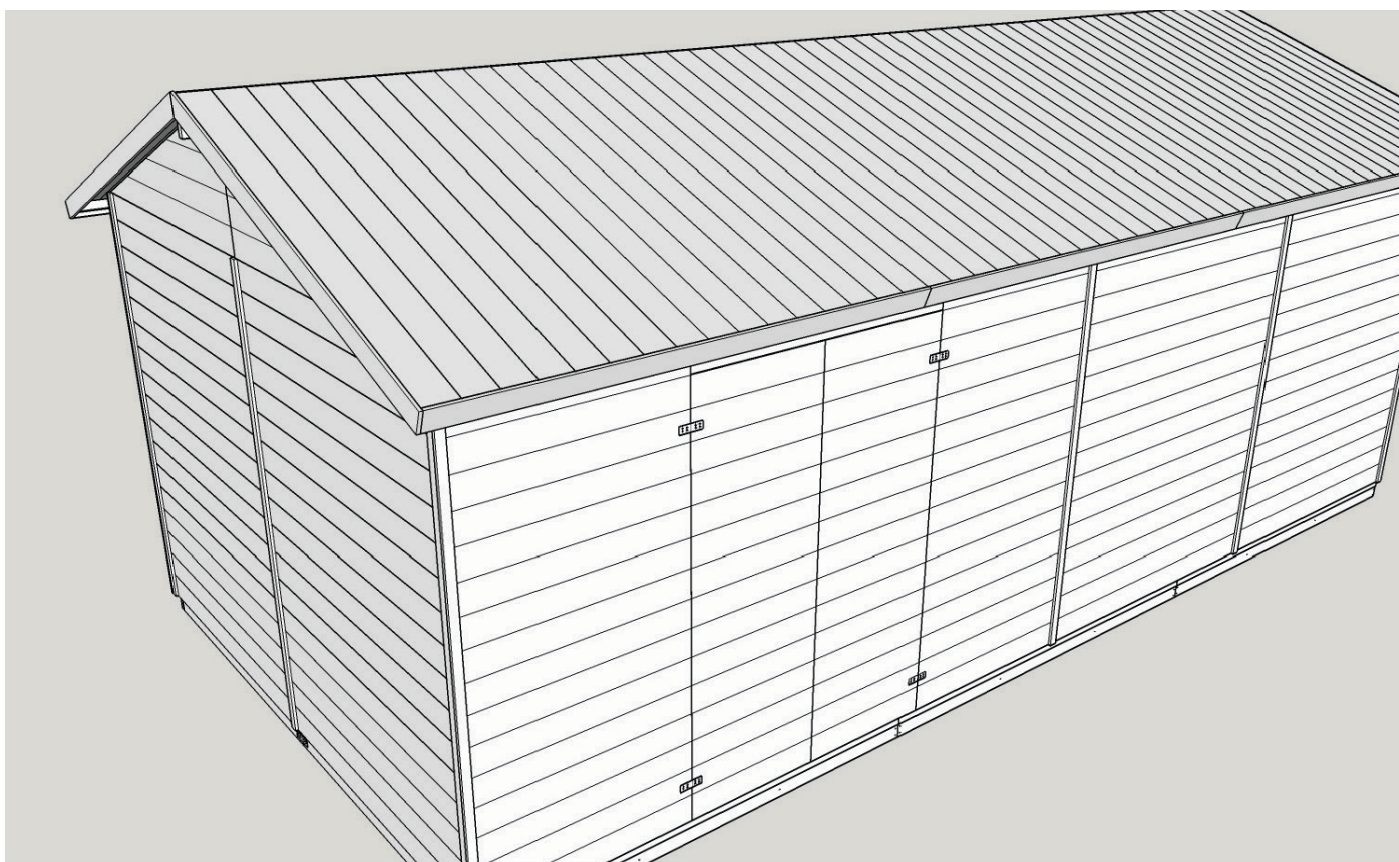
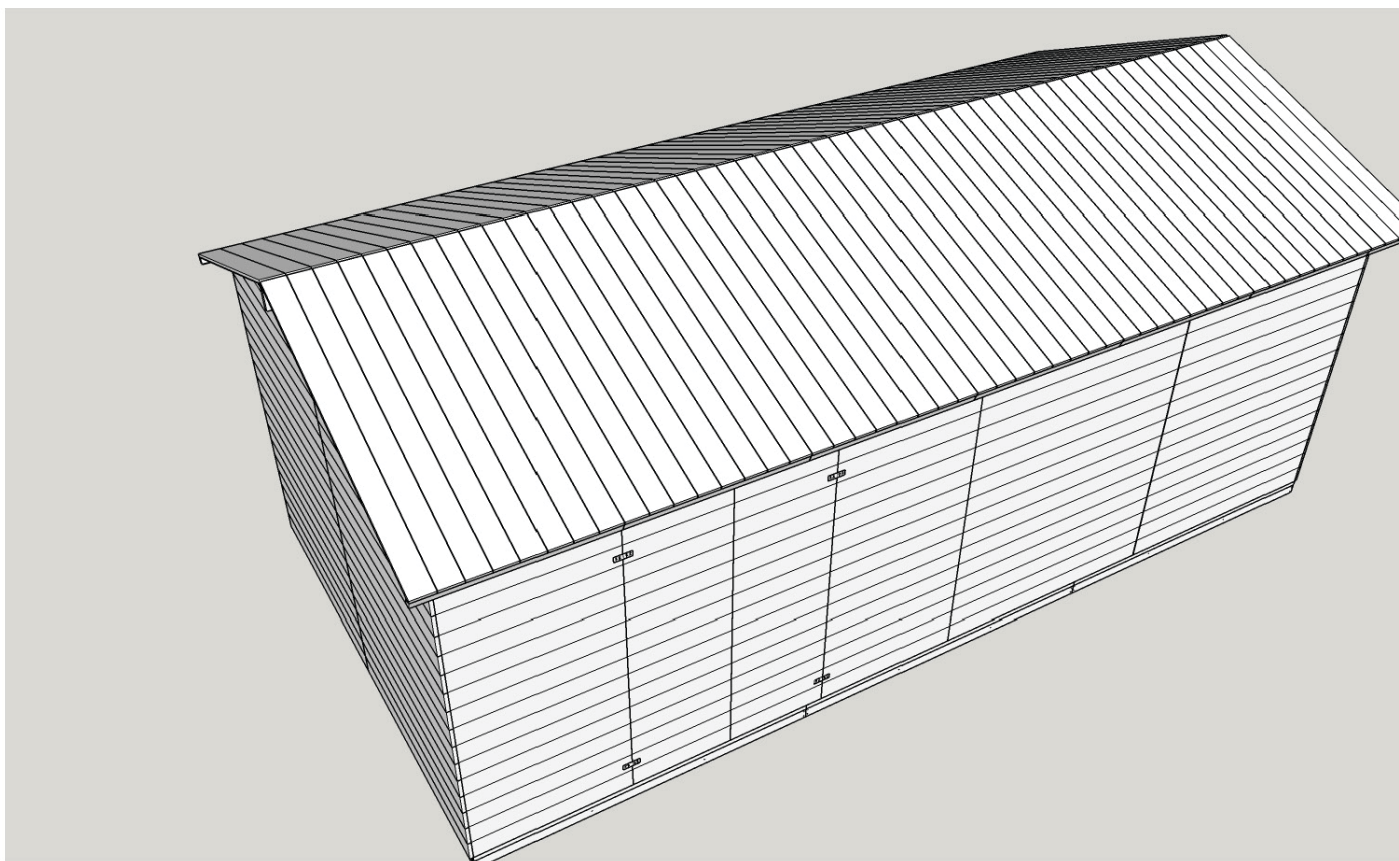

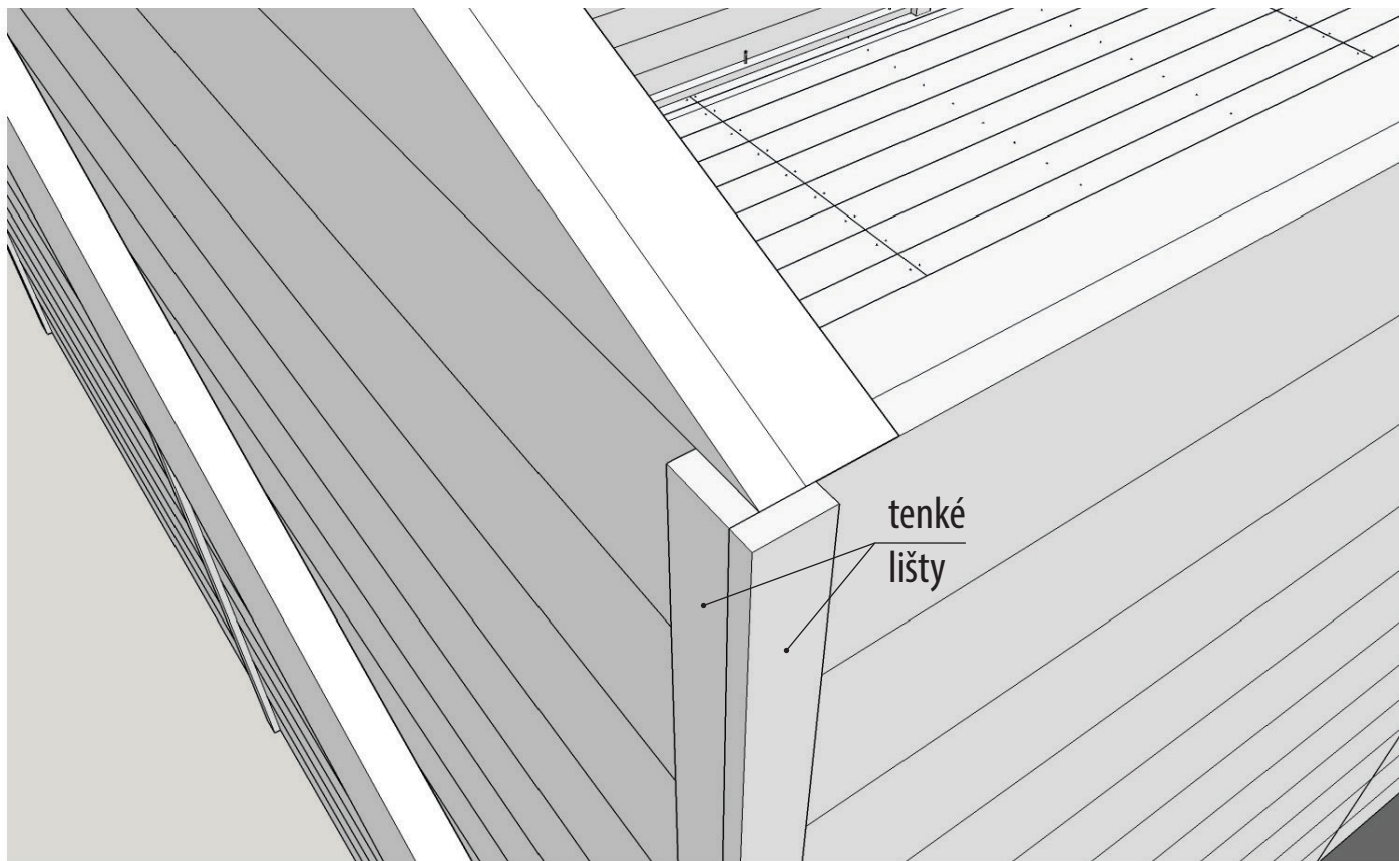

Postup při kladení asfaltové izolace

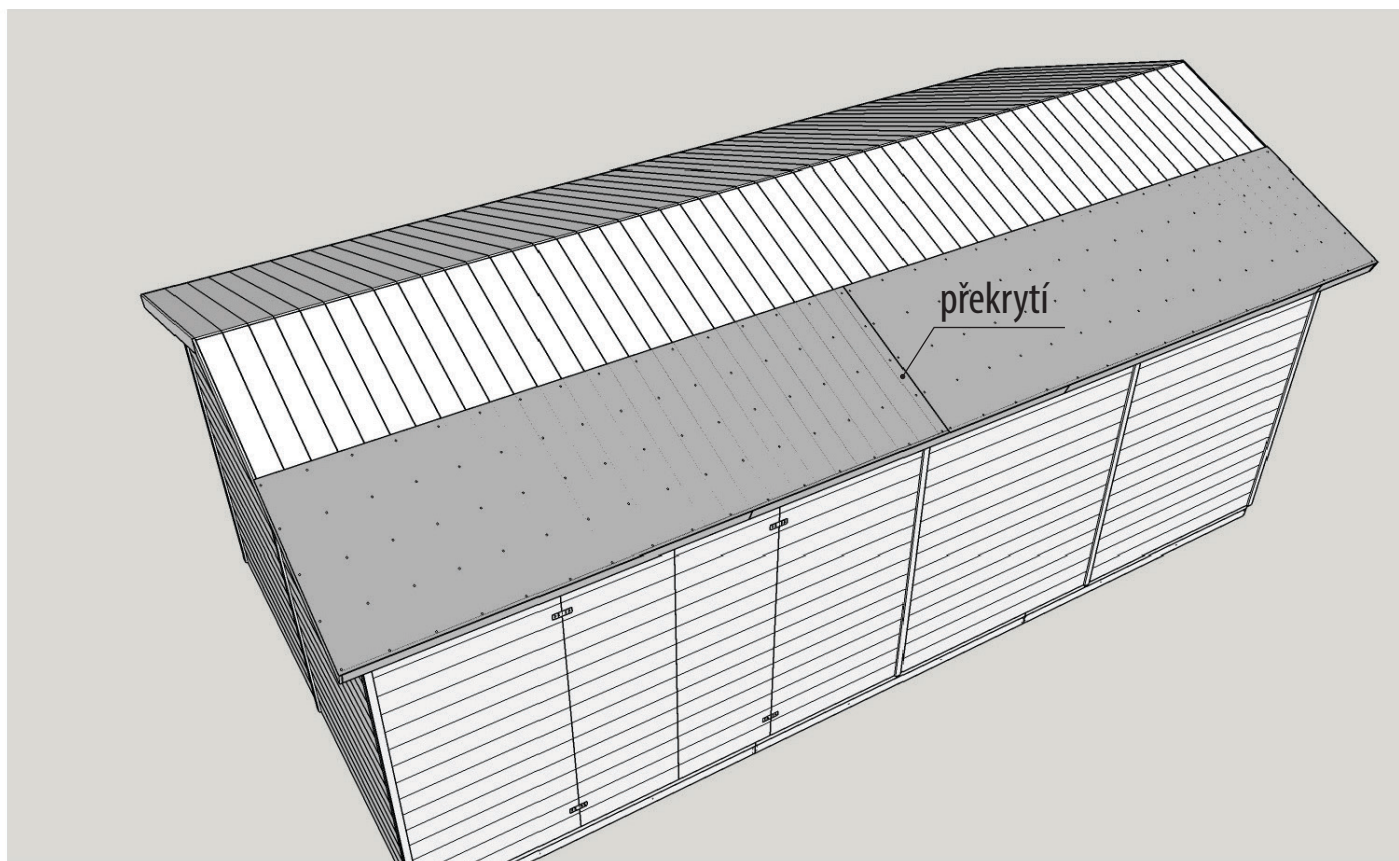

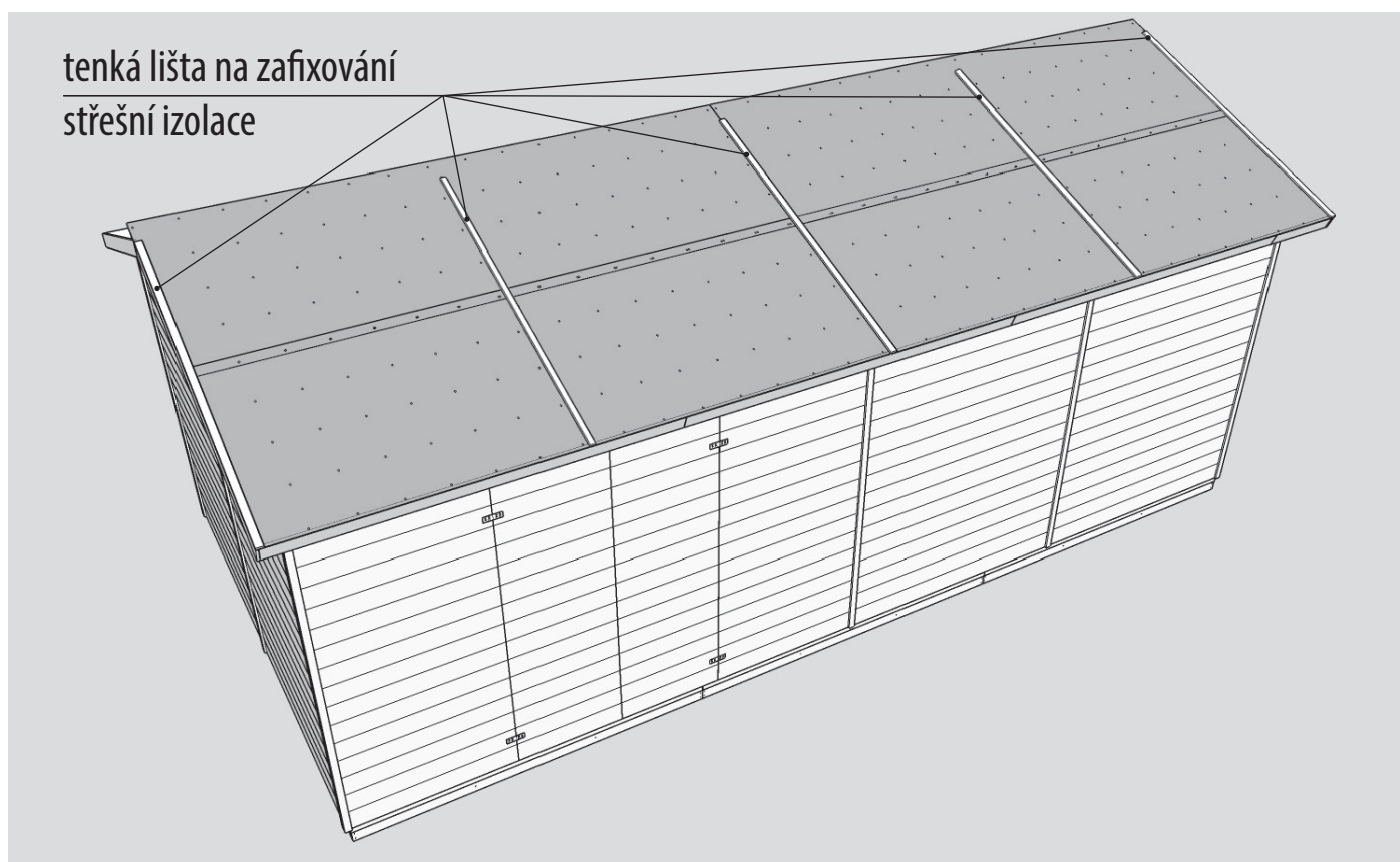
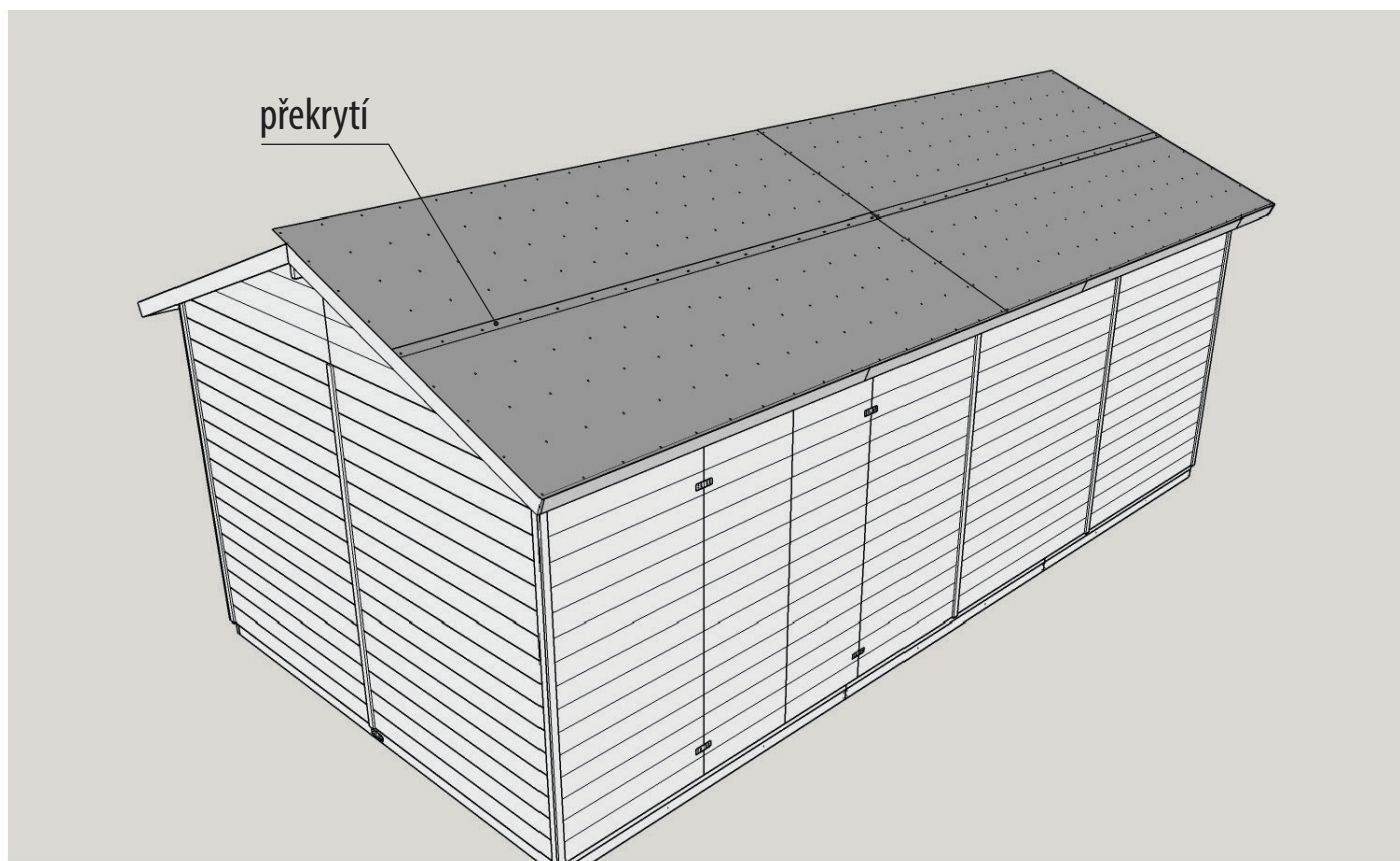

Děkujeme za výběr
zahradního domku z naší společnosti
a přejeme spokojené užívání.

Zahradní domky
MICHAL ZELMAN

www.nejzahradnidomek.cz

